

版本 REV.	日期 DATE	ECN NO.	变更内容 DESCRIPTION	制图 DRAWN

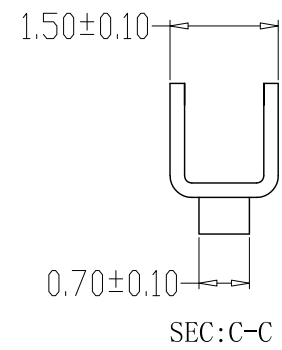
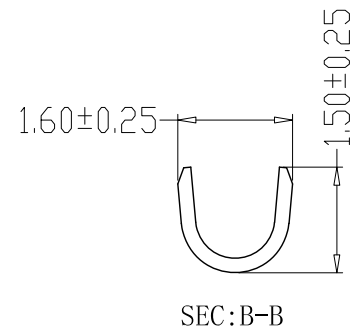
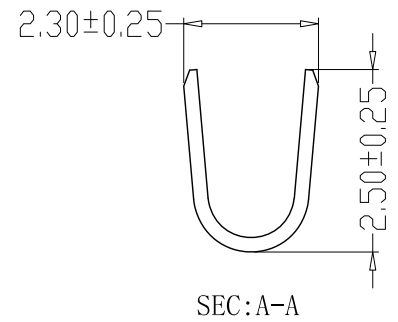
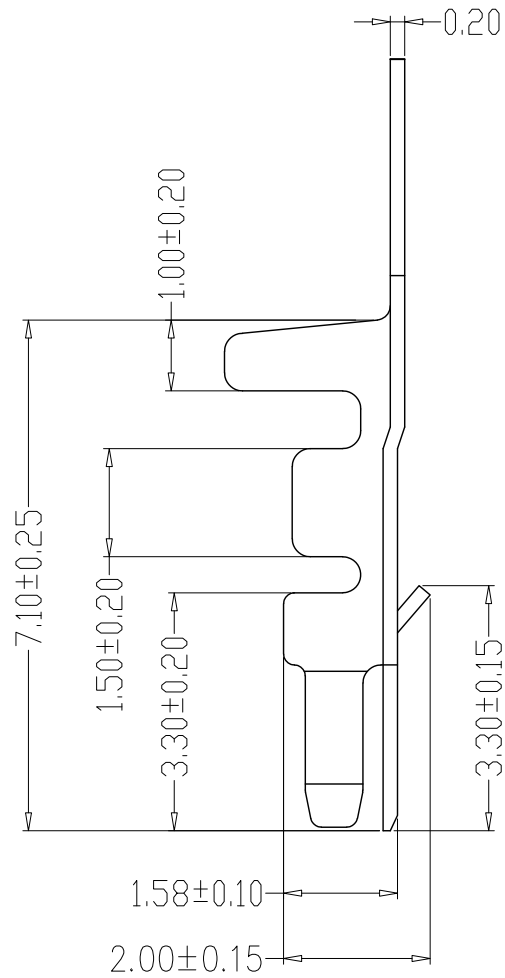
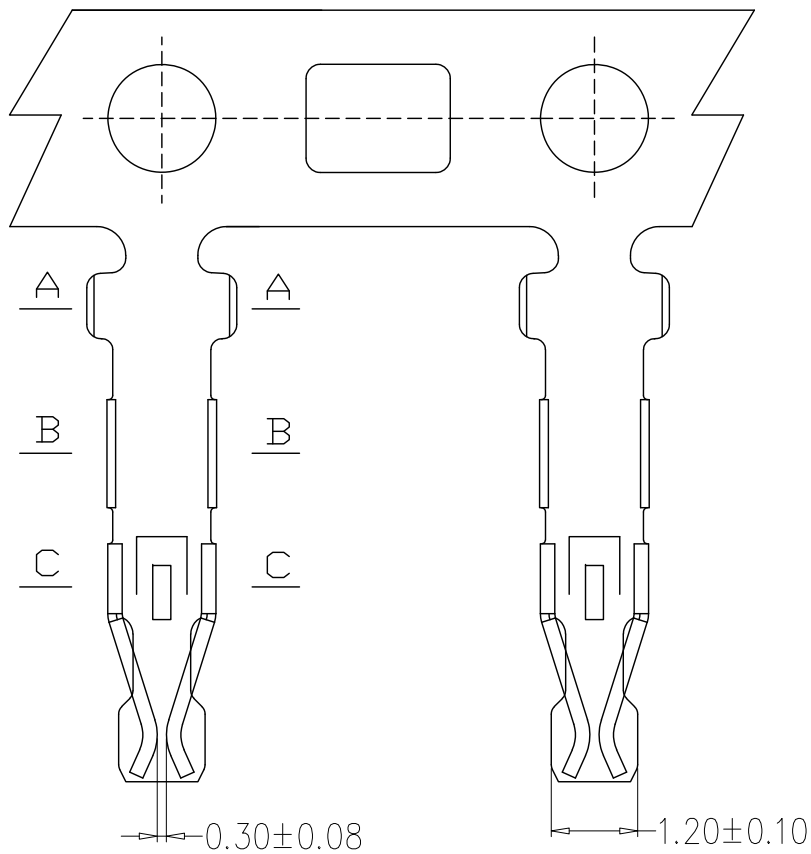

SPECIFICATIONS

- 1、Current Rating: 1A AC, DC
- 2、Voltage Rating: 600V AC, DC
- 3、Temperatuer Range: -25°C~+85°C
- 4、Contact Resistance: 20mΩ Max
- 5、Insulation Resistance: 1000MΩ Min
- 6、Withstanding Voltang: 1800V AC/minute
- 7、Material:Phosphoric bronze Tin-plated
- 8、Applicable Wire Sizes:AWG#22~28#

GENERAL TOLERANCE		制图 Mapping	张迎春 2022、09、19	料号 PART NO.	B40001-PT	版本 REV.	A
X±0.25	X°±2°	审核 Audit	钱岳生 2022、09、19	品名 TITLE	BH4.0母端	页次 SHEET	1/1
.X±0.25	.X°±1°	核准 Approved	张名 2022、09、20	客户料号 CUTM. NO.			
.XX±0.15	.XX°±0.5°	单位 Units	mm	比例 SCALE			
.XXX±0.10	.XXX°±0.5°			乐清市宏一电子有限公司 Yueqing HongYi Electronics Co., Ltd			

版本 REV.	日期 DATE	ECN NO.	变更内容 DESCRIPTION	制图 DRAWN

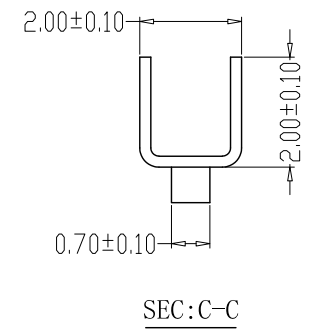
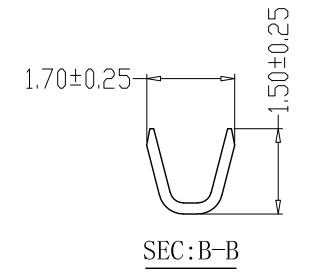
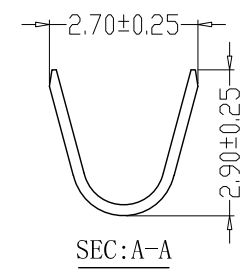
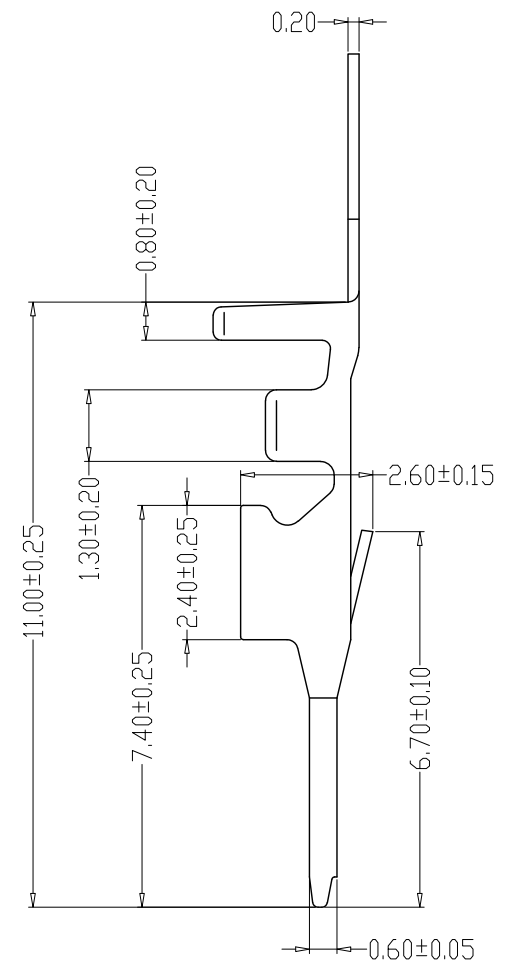
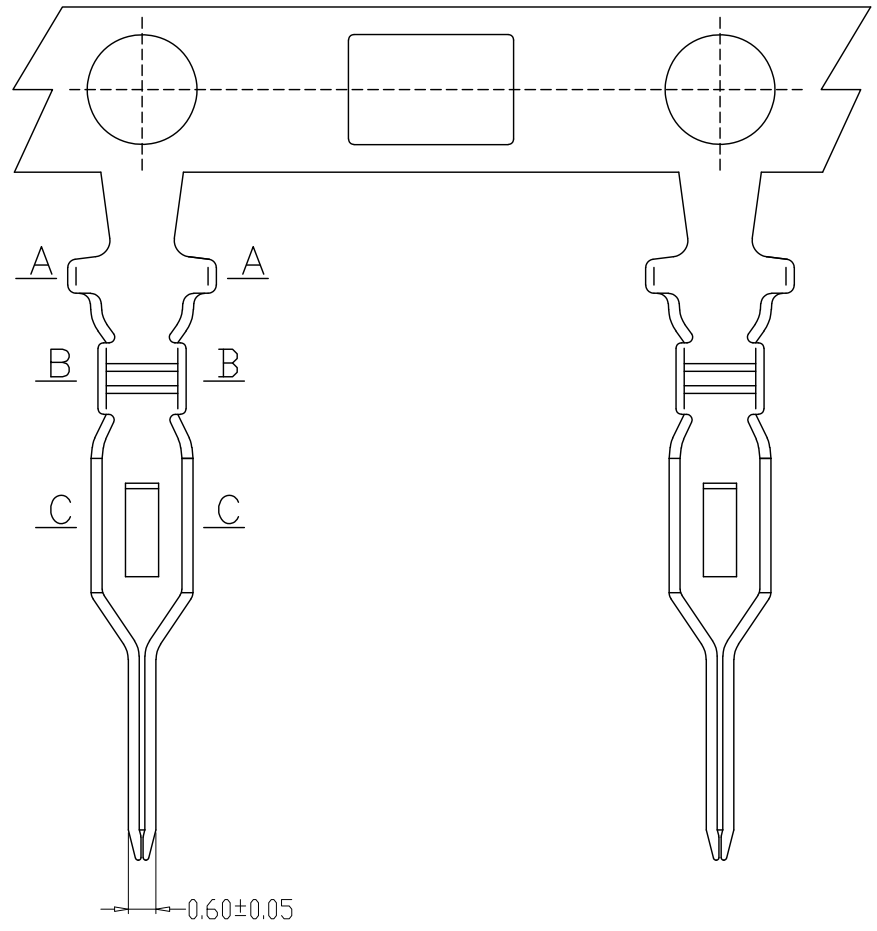

SPECIFICATIONS

- 1、Current Rating: 1A AC, DC
- 2、Voltage Rating: 600V AC, DC
- 3、Temperatuer Range: -25°C~+85°C
- 4、Contact Resistance: 20mΩ Max
- 5、Insulation Resistance: 1000MΩ Min
- 6、Withstanding Voltang: 1800V AC/minute
- 7、Material:Phosphoric bronze Tin-plated
- 8、Applicable Wire Sizes:AWG#22~28#

GENEERL TOLERANCE		制图 Mapping	张迎春 2022、09、19	料号 PART NO.	B40001-RT	版本 REV.	A
X.±0.25	X.°±2°	审核 Audit	钱岳生 2022、09、19	品名 TITLE	BH4.0公端	页次 SHEET	1/1
.X±0.25	.X°±1°	核准 Approved	张名 2022、09、20	客户料号 CUTM. NO.			
.XX±0.15	.XX°±0.5°	单位 Units	mm	比例 SCALE			
.XXX±0.10	.XXX°±0.5°			乐清市宏一电子有限公司 Yueqing HongYi Electronics Co., Ltd			

版本 REV.	日期 DATE	ECN NO.	变更内容 DESCRIPTION	制图 DRAWN

SPECIFICATIONS

- 1、 Current Rating: 1A AC, DC
- 2、 Voltage Rating: 600V AC, DC
- 3、 Temperatuer Range: -25°C~+85°C
- 4、 Contact Resistance: 20mΩ Max
- 5、 Insulation Resistance: 1000MΩ Min
- 6、 Withstanding Voltang: 1800V AC/minute
- 7、 Material: PA66, UL94V-0

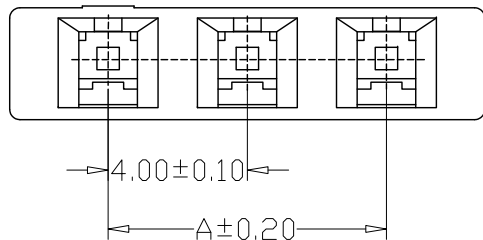
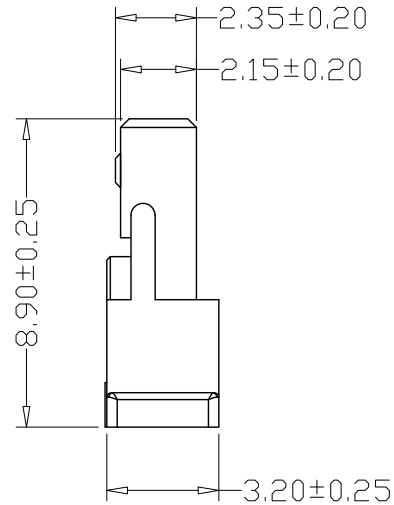
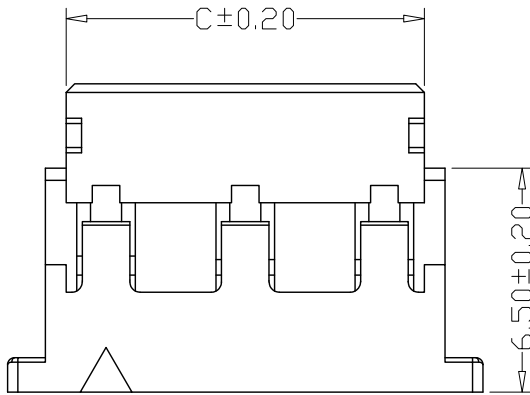
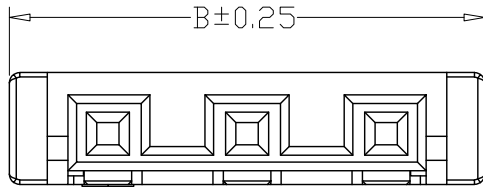
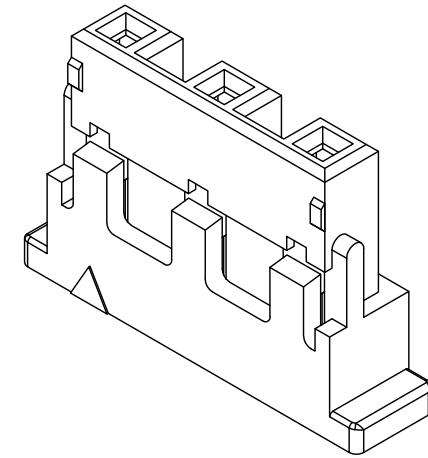

编号	尺寸 (mm)		
	A	B	C
-02P	4.00	9.80	6.40
-03P	8.00	13.80	10.40
-04P	12.00	17.80	14.40
-05P	16.00	21.80	18.40

GENERAL TOLERANCE		制图 Mapping	张迎春 2022、09、19		料号 PART NO.	B40001-nP		版本 REV.	A
X.±0.25	X.°±2°	审核 Audit	钱岳生 2022、09、19		品名 TITLE	BH4.0公壳		页次 SHEET	1/1
.X±0.25	.X°±1°		核准 Approved		客户料号 CUTM. NO.				
.XX±0.15	.XX°±0.5°	张名 2022、09、20				乐清市宏一电子有限公司 YueQing HongYi Electronics Co., Ltd			
.XXX±0.10	.XXX°±0.5°	单位 Units	mm						比例 SCALE

版本 REV.	日期 DATE	ECN NO.	变更内容 DESCRIPTION	制图 DRAWN

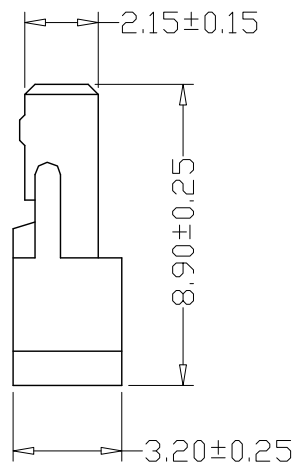
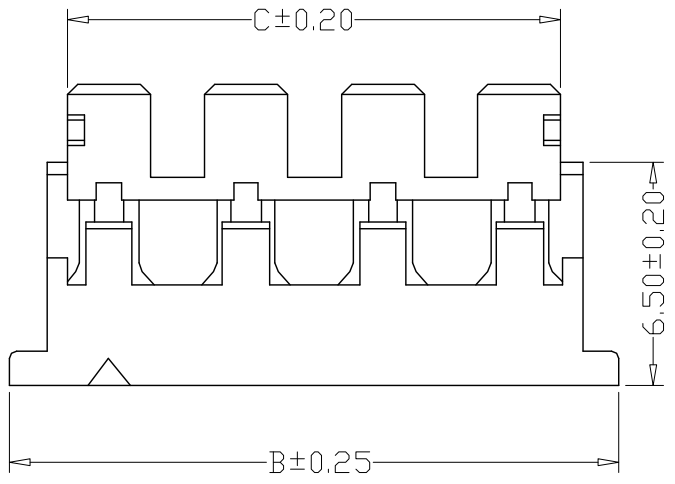
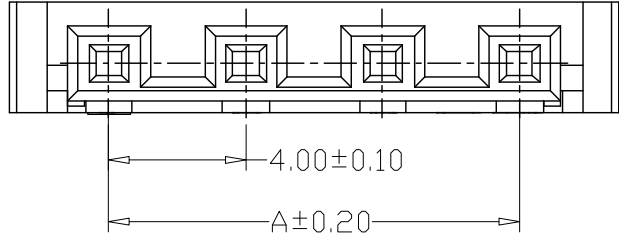

SPECIFICATIONS

- 1、Current Rating: 1A AC, DC
- 2、Voltage Rating: 600V AC, DC
- 3、Temperatuer Range: -25°C~+85°C
- 4、Contact Resistance: 20mΩ Max
- 5、Insulation Resistance: 1000MΩ Min
- 6、Withstanding Voltang: 1800V AC/minute
- 7、Material: PA66, UL94V-0

编号	尺寸 (mm)		
	A	B	C
-02P1	4.00	9.80	6.40
-03P1	8.00	13.80	10.40
-04P1	12.00	17.80	14.40
-05P1	16.00	21.80	18.40

GENEAL TOLERANCE		制图 Mapping	张迎春 2022、09、19	料号 PART NO.	B40001-nP1	版本 REV.	A
X±0.25	X°±2°	审核 Audit	钱岳生 2022、09、19	品名 TITLE	BH4.0公壳	页次 SHEET	1/1
.X±0.25	.X°±1°			核准 Approved	张名 2022、09、20	客户料号 CUTM. NO.	
.XX±0.15	.XX°±0.5°	单位 Units	mm	比例 SCALE		乐清市宏一电子有限公司 Yueqing HongYi Electronics Co., Ltd	
.XXX±0.10	.XXX°±0.5°						

版本 REV.	日期 DATE	ECN NO.	变更内容 DESCRIPTION	制图 DRAWN

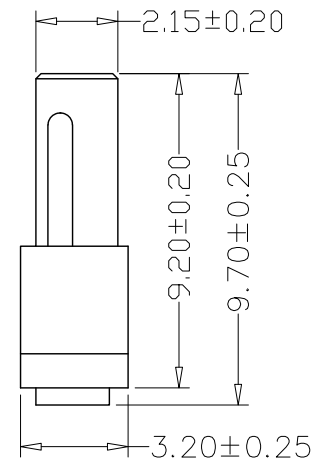
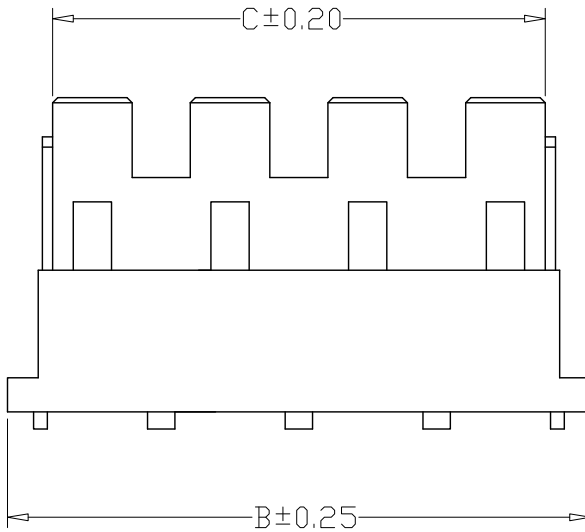
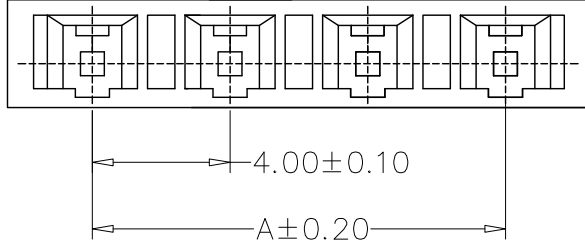

SPECIFICATIONS

- 1、Current Rating: 1A AC, DC
- 2、Voltage Rating: 600V AC, DC
- 3、Temperatuer Range: -25℃~+85℃
- 4、Contact Resistance: 20mΩ Max
- 5、Insulation Resistance: 1000MΩ Min
- 6、Withstanding Voltang: 1800V AC/minute
- 7、Material: PA66, UL94V-0

编号	尺寸 (mm)		
	A	B	C
-02P2	4.00	9.80	6.40
-03P2	8.00	13.80	10.40
-04P2	12.00	17.80	14.40
-05P2	16.00	21.80	18.40

GENEAL TOLERANCE		制图 Mapping	张迎春 2022、09、19	料号 PART NO.	B40001-nP2	版本 REV.	A
X±0.25	X°±2°	审核 Audit	钱岳生 2022、09、19	品名 TITLE	BH4.0公壳	页次 SHEET	1/1
.X±0.25	.X°±1°	核准 Approved	张名 2022、09、20	客户料号 CUTM. NO.			
.XX±0.15	.XX°±0.5°	单位 Units	mm	比例 SCALE			
.XXX±0.10	.XXX°±0.5°				 乐清市宏一电子有限公司 YueQing HongYi Electronics Co., Ltd		

版本 REV.	日期 DATE	ECN NO.	变更内容 DESCRIPTION	制图 DRAWN

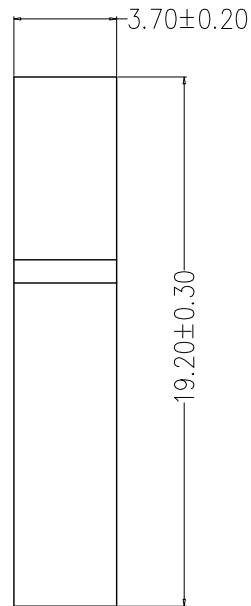
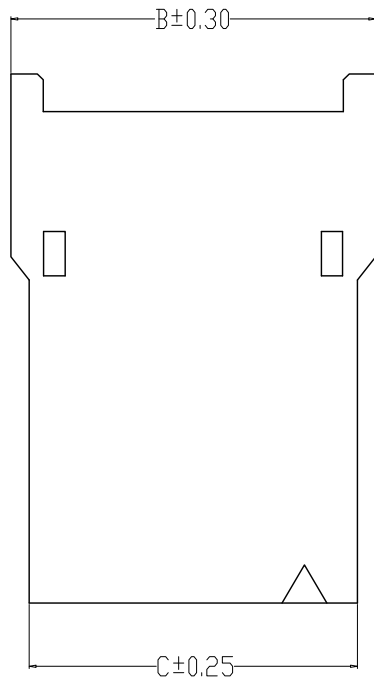
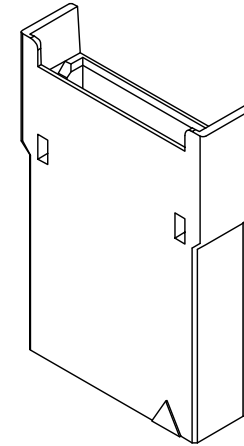
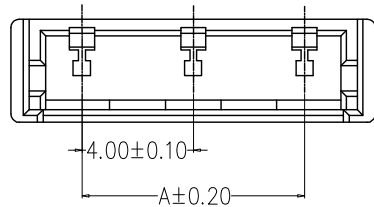

SPECIFICATIONS

- 1、Current Rating: 1A AC, DC
- 2、Voltage Rating: 600V AC, DC
- 3、Temperatuer Range: -25℃~+85℃
- 4、Contact Resistance: 20mΩ Max
- 5、Insulation Resistance: 1000MΩ Min
- 6、Withstanding Voltang: 1800V AC/minute
- 7、Material: PA66, UL94V-0

编号	尺寸 (mm)		
	A	B	C
-02R	4.00	9.20	8.00
-03R	8.00	13.20	12.00
-04R	12.00	17.20	16.00
-05R	16.00	21.20	20.00

GENEAL TOLERANCE		制图 Mapping	张迎春 2022、09、19		料号 PART NO.	B40001-nR		版本 REV.	A
X.±0.25	X.°±2°	审核 Audit	钱岳生 2022、09、19		品名 TITLE	BH4.0母壳		页次 SHEET	1/1
.X±0.25	.X°±1°		核准 Approved		客户料号 CUTM. NO.				
.XX±0.15	.XX°±0.5°	张名 2022、09、20							
.XXX±0.10	.XXX°±0.5°	单位 Units	mm						比例 SCALE

版本 REV.	日期 DATE	ECN NO.	变更内容 DESCRIPTION	制图 DRAWN

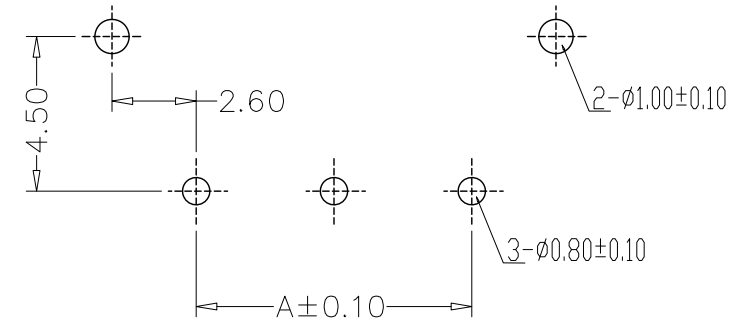
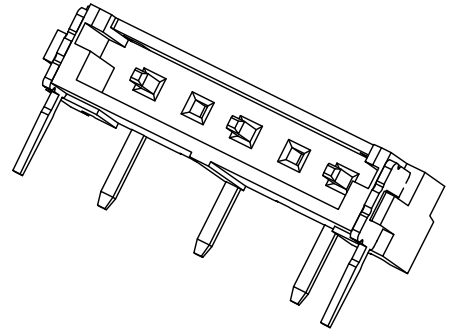
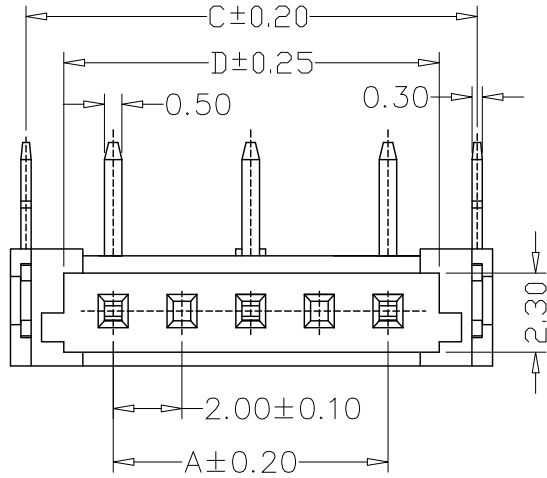

PCB LAYOUT

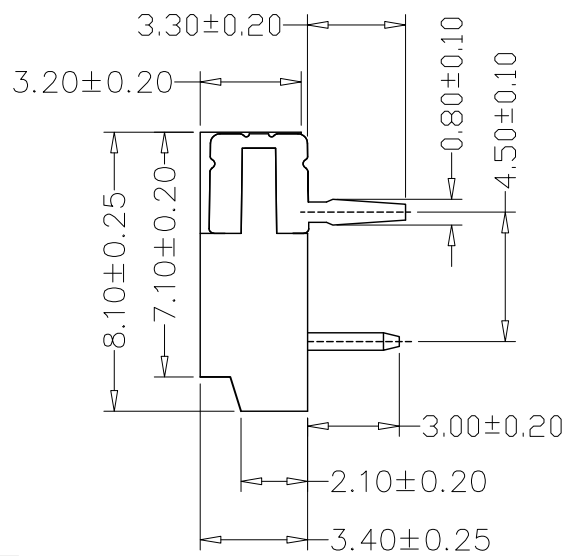
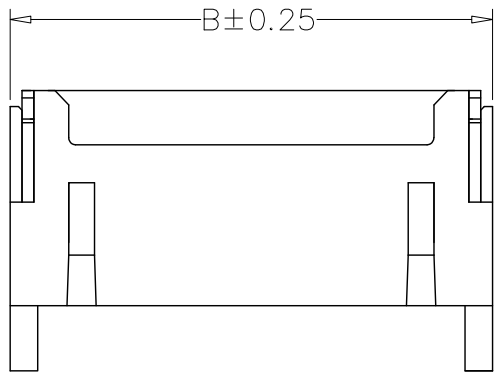

SPECIFICATIONS

- 1、Current Rating: 1A AC, DC
- 2、Voltage Rating: 600V AC, DC
- 3、Temperatuer Range: -25℃~+85℃
- 4、Contact Resistance: 20mΩ Max
- 5、Insulation Resistance: 1000MΩ Min
- 6、Withstanding Voltang: 1800V AC/minute
- 7、Material: PA6T, UL94V-0
PIN Brass Tin-plated
Solder foot Brass Tin-plated

编号	尺寸 (mm)			
	A	B	C	D
-02AW	4.00	10.00	8.80	6.50
-03AW	8.00	14.00	12.80	10.50
-04AW	12.00	18.00	16.80	14.50
-05AW	16.00	22.00	20.80	18.50

GENERAL TOLERANCE		制图 Mapping	张迎春 2022、09、19		料号 PART NO.	B40001-5A3TW		版本 REV.	A
X±0.25	X°±2°	审核 Audit	钱岳生 2022、09、19		品名 TITLE	BH4.0弯针 WAFER DIP TYPE		页次 SHEET	1/2
.XX±0.25	.X°±1°		核准 Approved		客户料号 CUTM. NO.				
.XX±0.15	.XX°±0.5°	单位 Units	mm	比例 SCALE	乐清市宏一电子有限公司 Yueqing HongYi Electronics Co., Ltd				
.XXX±0.10	.XXX°±0.5°								

版本 REV.	日期 DATE	ECN NO.	变更内容 DESCRIPTION	制图 DRAWN

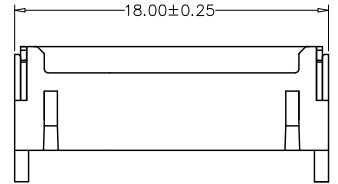
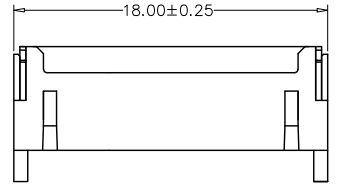
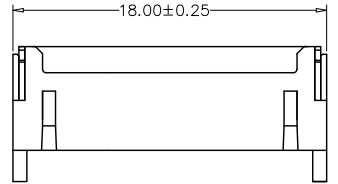
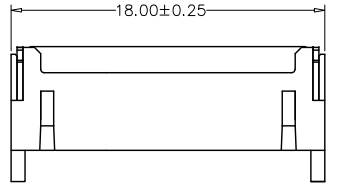
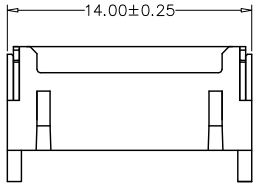
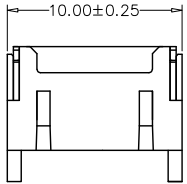
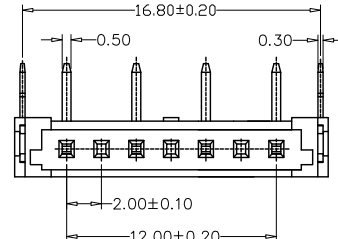
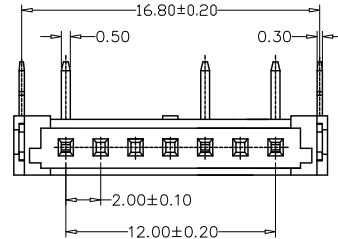
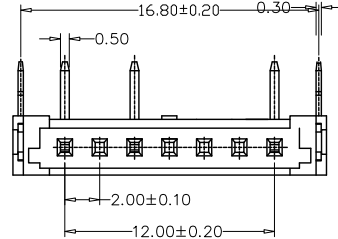
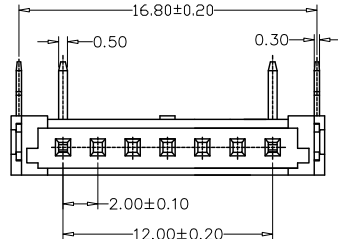
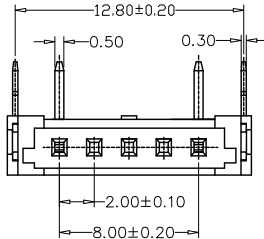
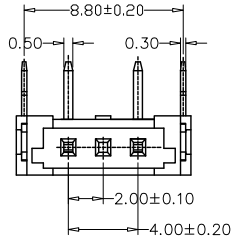

3A2TW

5A2TW

7A2TW

7A3TW

7A3TW-TYPE1

7A4TW

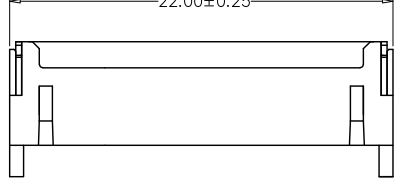
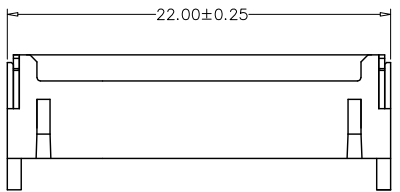
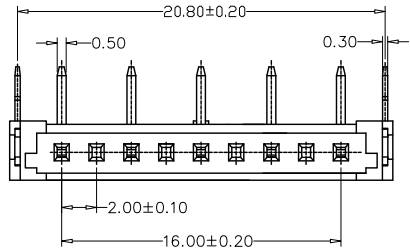
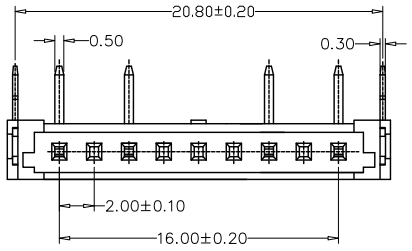

9A4TW

9A5TW

GENERAL TOLERANCE		制图 Mapping	张迎春 2022、09、19	料号 PART NO.	B40001-nAW	版本 REV.	A
X±0.25	X°±2°	审核 Audit	钱岳生 2022、09、19	品名 TITLE	BH4.0弯针 WAFER DIP TYPE	页次 SHEET	2/2
.X±0.25	.X°±1°	核准 Approved	张名 2022、09、20	客户料号 CUTM. NO.			
.XX±0.15	.XX°±0.5°	单位 Units	mm	比例 SCALE			
.XXX±0.10	.XXX°±0.5°						

乐清市宏一电子有限公司
YueQing HongYi Electronics Co., Ltd

版本 REV.	日期 DATE	ECN NO.	变更内容 DESCRIPTION	制图 DRAWN

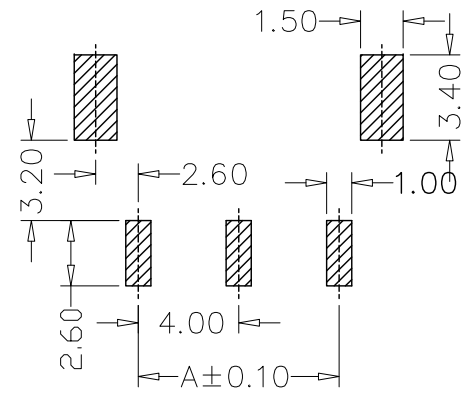
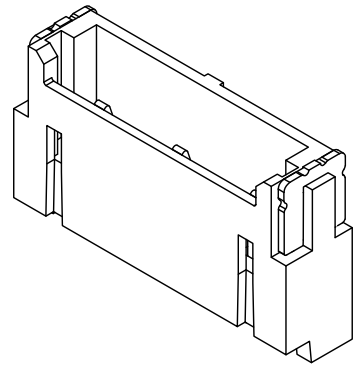
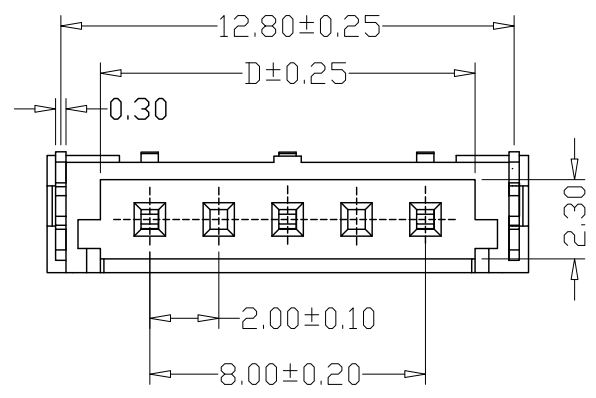

PCB LAYOUT

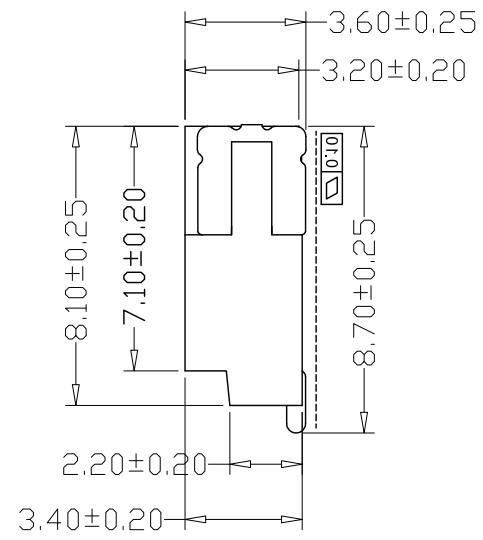
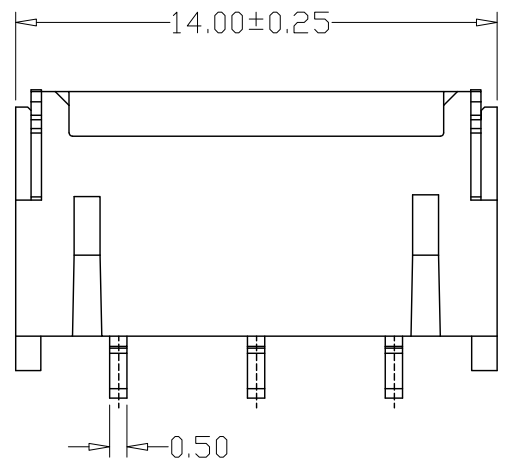

SPECIFICATIONS

- 1、Current Rating: 1A AC, DC
- 2、Voltage Rating: 600V AC, DC
- 3、Temperatuer Range: -25°C~+85°C
- 4、Contact Resistance: 10mΩ Max
- 5、Insulation Resistance: 1000MΩ Min
- 6、Withstanding Voltang: 1800V AC/minute
- 7、Material: PA6T, UL94V-0
PIN Brass Tin-plated
Solder tad Brass Tin-plated

编号	尺寸 (mm)			
	A	B	C	D
-02AWB	4.00	10.00	8.80	6.50
-03AWB	8.00	14.00	12.80	10.50
-04AWB	12.00	18.00	16.80	14.50
-05AWB	16.00	22.00	20.80	18.50

GENREL TOLERANCE		制图 Mapping	张迎春 2022、09、19	料号 PART NO.	B40001-5A3TWB	版本 REV.	A
X±0.25	X°±2°	审核 Audit	钱岳生 2022、09、19	品名 TITLE	BH4.0卧贴 WAFER SMT TYPE	页次 SHEET	1/2
.X±0.25	.X°±1°	核准 Approved	张名 2022、09、20	客户料号 CUTM. NO.			
.XX±0.15	.XX°±0.5°	单位 Units	mm	比例 SCALE			
.XXX±0.10	.XXX°±0.5°			乐清市宏一电子有限公司 Yueqing HongYi Electronics Co., Ltd			

版本 REV.	日期 DATE	ECN NO.	变更内容 DESCRIPTION	制图 DRAWN

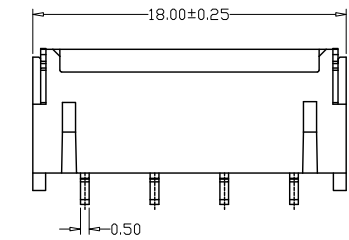
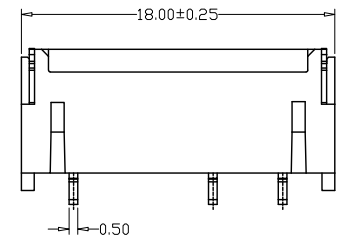
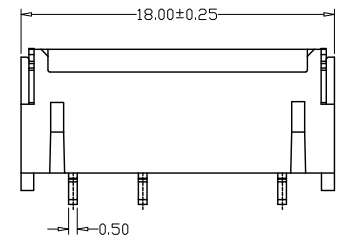
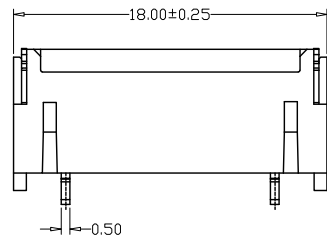
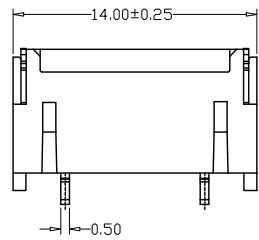
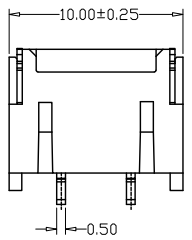
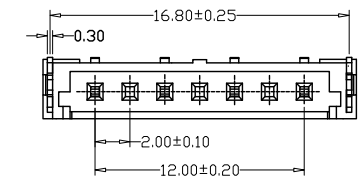
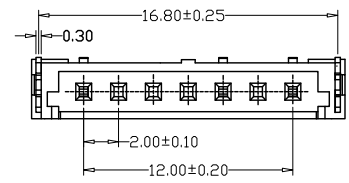
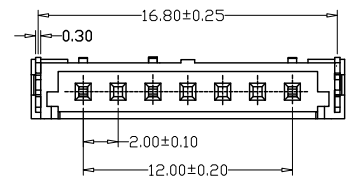
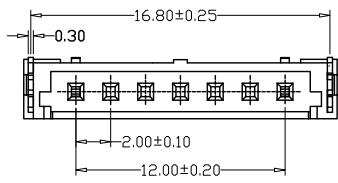
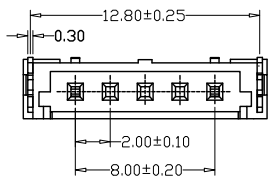
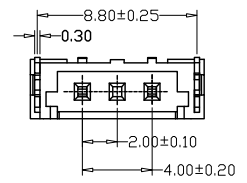

3A2TWB

5A2TWB

7A2TWB

7A3TWB

7A3TWB-TYPE1

7A4TWB

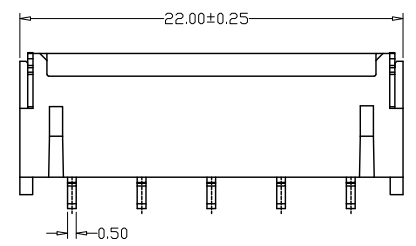
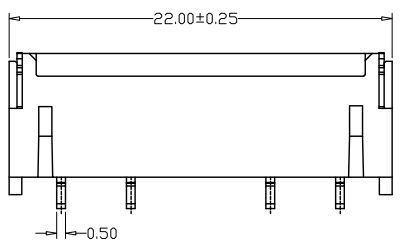
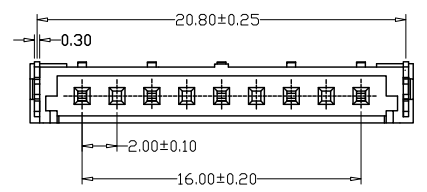
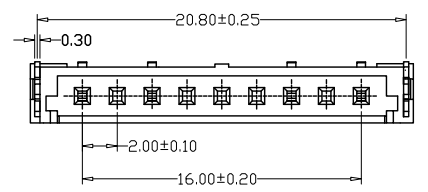

9A4TWB

9A5TWB

GENERAL TOLERANCE		制图 Mapping	张迎春 2022、09、19	料号 PART NO.	B40001-nAWB	版本 REV.	A
X±0.25	X°±2°	审核 Audit	钱岳生 2022、09、19	品名 TITLE	BH4.0卧贴 WAFER SMT TYPE	页次 SHEET	2/2
.X±0.25	.X°±1°	核准 Approved	张名 2022、09、20	客户料号 CUTM. NO.			
.XX±0.15	.XX°±0.5°	单位 Units	mm	比例 SCALE			
.XXX±0.10	.XXX°±0.5°			 乐清市宏一电子有限公司 YueQing HongYi Electronics Co., Ltd			